

Please Call For Assistance
 Ph: 631-293-8273
 Fax: 631-293-3617
 e-mail: Support@rajack.com

Rajack Designs, Ltd.

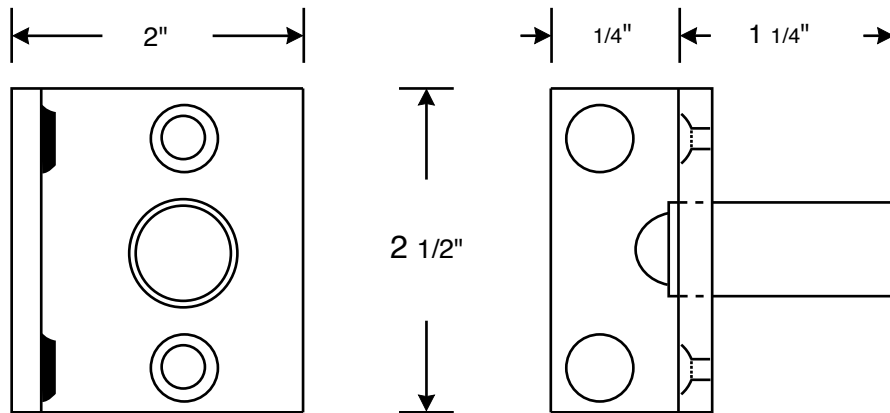
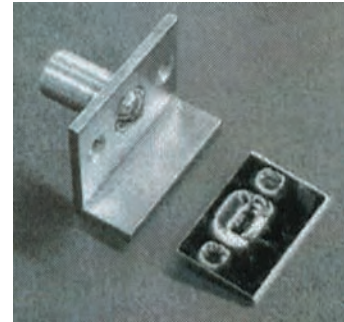
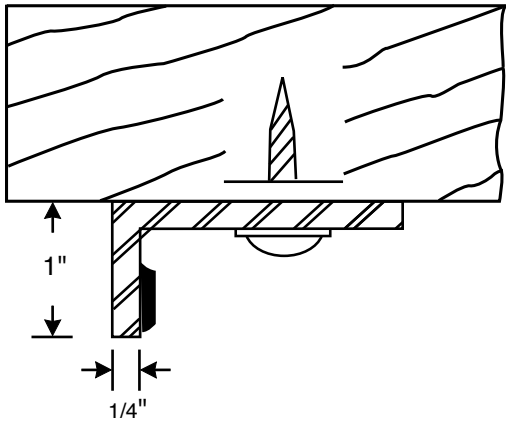

Depth: 2"
 Width: 1/4"
 Length: See Size List

Standard Sizes

2 1/2"
 3"

Standard Finishes

- US3 - Polished Brass
- US3A - Polished Brass (No Lacquer)
- US4 - Satin Brass
- US4A - Satin Brass (No Lacquer)
- US10 - Bright Bronze
- US10B - Oil Rubbed Bronze
- US14 - Polished Nickel
- US15 - Satin Nickel
- US26 - Polished Chrome
- US26D - Satin Chrome

RJ1072 Angle Stop & Ball Catch (For pair of doors use 2 pcs.)

Rajack Designs, Ltd.

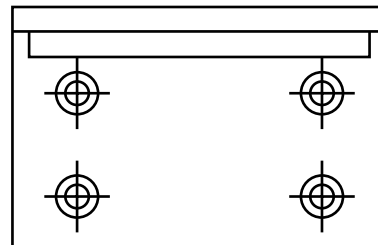
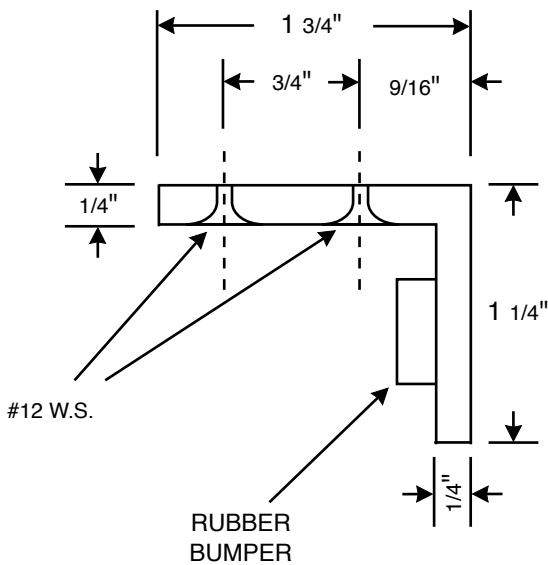
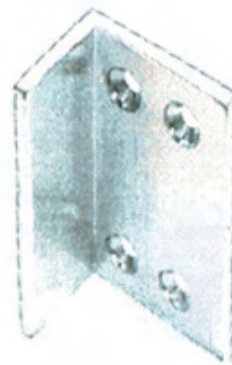
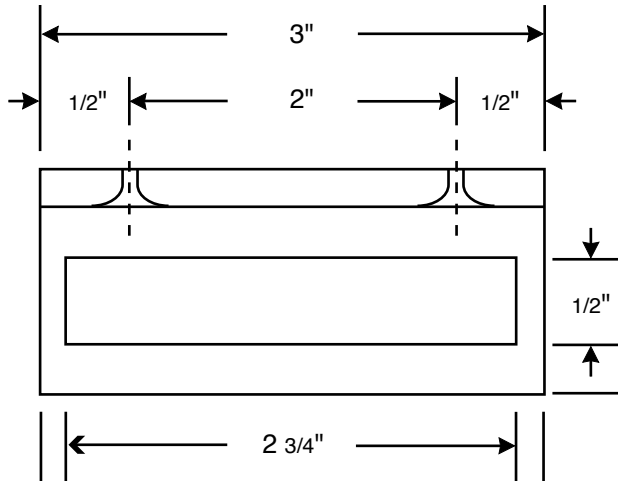

Depth: 00/00"
 Width: 00/00"
 Length: 00/00"

Standard Sizes
 1 1/2"
 3"

Standard Finishes

- US3 - Polished Brass
- US3A - Polished Brass (No Lacquer)
- US4 - Satin Brass
- US4A - Satin Brass (No Lacquer)
- US10 - Bright Bronze
- US10B - Oil Rubbed Bronze
- US14 - Polished Nickel
- US15 - Satin Nickel
- US26 - Polished Chrome
- US26D - Satin Chrome

1336 For Pair Of Doors Or 1333 Angle Stop For Single Door